

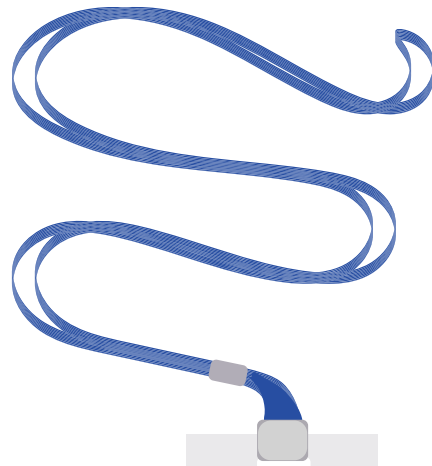

# SIOP ANNUAL CONFERENCE

DENVER, COLORADO • April 2-5, 2025

## Badge Lanyard



**Sponsorship Fee**

\$12,500

# SOLD

### **Additional Info**

---

Your logo on attendee lanyards. Quantity to be determined.

**Thank You... PDRI by Pearson**

# Hotel Keycard



**Sponsorship Fee  
Additional Info**

**SOLD**

---

Your message on the room keycards for the primary conference hotel only.  
Quantity to be determined.

**Thank You... Hogan Assessments**



# SIOP ANNUAL CONFERENCE

DENVER, COLORADO • April 2-5, 2025

## Conference Career Center Sponsor



### Sponsorship Fee

\$5,000

### Additional Info

---

- A welcome email to all registered job seekers one week prior to the annual conference highlighting the sponsor's job openings.
- Recognition as host of the CCC Open House and ability to put branded swag out on cocktail tables.
- Logo on all CCC promo emails and onsite signage.
- One (1) complimentary CCC employer subscription
- Post-event thank you email to all jobseekers highlighting the sponsor's job openings.



# SIOP ANNUAL CONFERENCE

DENVER, COLORADO • April 2-5, 2025

## Partner Showcases



**09 Sold**

### Sponsorship Fee

**\$5,000**

### Additional Info

---

### Thank You...

**Arcadia Consulting  
Berman Leadership Development  
Deloitte Consulting  
Multi-Health Systems  
Pinsight  
SHL  
Valence**

This is not a commercial to sell your product or service, nor is it a product demo but a session identified to attendees as produced and presented by a partner that provides the same level of quality content as a regular concurrent session. Each showcase will be held in-person only at the same time as concurrent sessions and in a location convenient for attendees. These sessions are not recorded. Partners can hire the official 2025 AV provider to video record their own presentations for later use.



**SIOP ANNUAL  
CONFERENCE**

DENVER, COLORADO • April 2-5, 2025

# Tech Exploration Demos

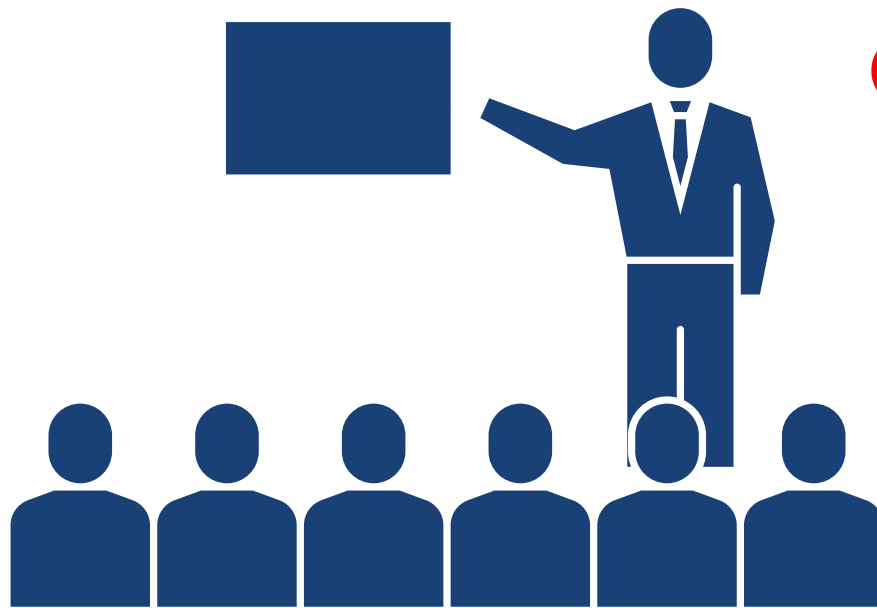

**01 Sold**

**Sponsorship Fee**

**\$5,000**

**Thank You...  
Deloitte Consulting**

**Additional Info**

---

Demonstrate your software, product, or service. The Tech Demos will be held in-person only at the same time as concurrent sessions in a location convenient for attendees. These sessions are not recorded. Partners can hire the official 2025 AV provider to video record their own presentations for later use.

# Ribbon Board

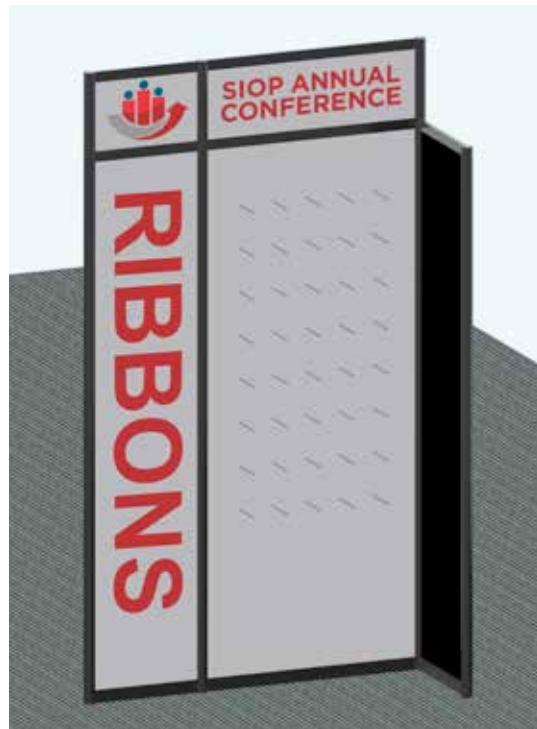

**Sponsorship Fee**

**\$3,500**

## **Additional Info**

---

Your logo prominently displayed on the conference ribbon rack, which will be located in the registration area. Attendees love to add ribbons to their badge to signify their membership status and their volunteer involvement, among other things. SIOP will include fun ribbons, too. No artwork required.



# SIOP ANNUAL CONFERENCE

DENVER, COLORADO • April 2-5, 2025

## Lobby F Atrium Window Cling

Single Sided Facing Atrium

OPPORTUNITY #1

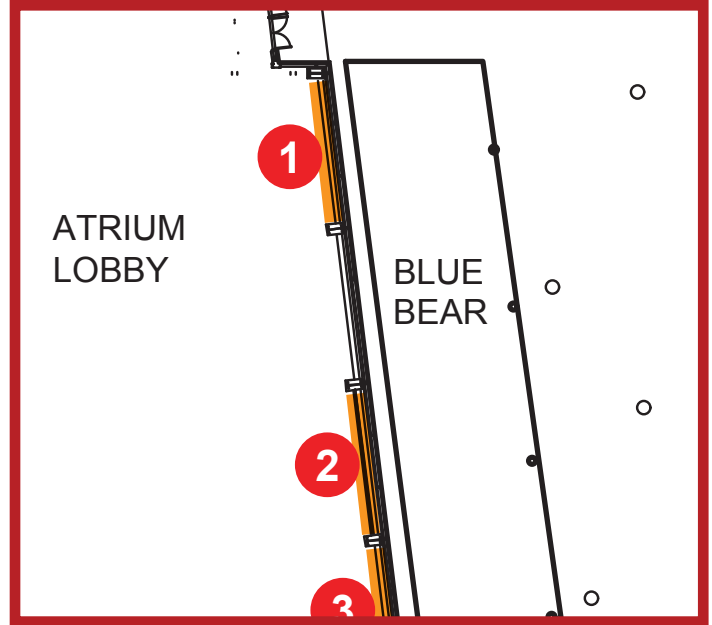

### Printing & Installation Fee

\$7,500

### Cling

27'10" W x 13'11" H

### Additional Info

Cling installed on windows near the iconic Blue Bear statue. Banner faces in towards Atrium Lobby A/F. Great view of your Cling from the entire atrium lobby.

# SOLD

Thank You... Valence



# SIOP ANNUAL CONFERENCE

DENVER, COLORADO • April 2-5, 2025

## Lobby F Atrium Window Cling

Single Sided Facing Atrium

OPPORTUNITY #2

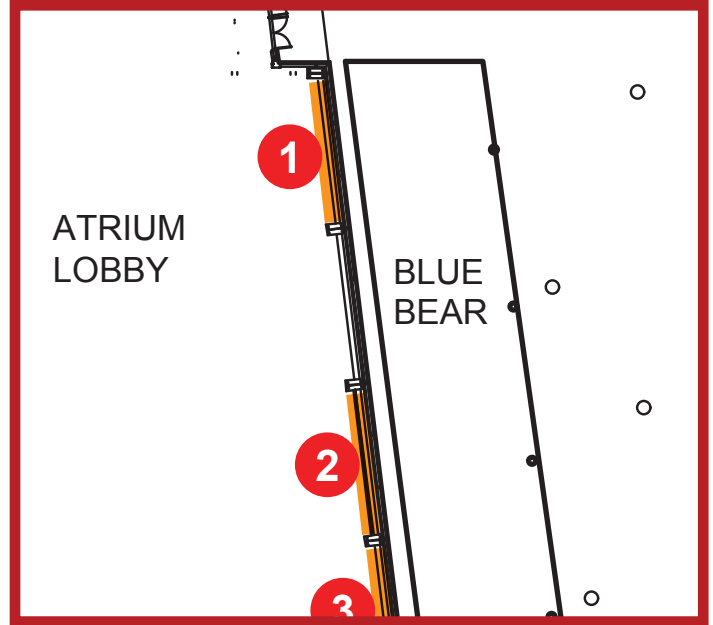
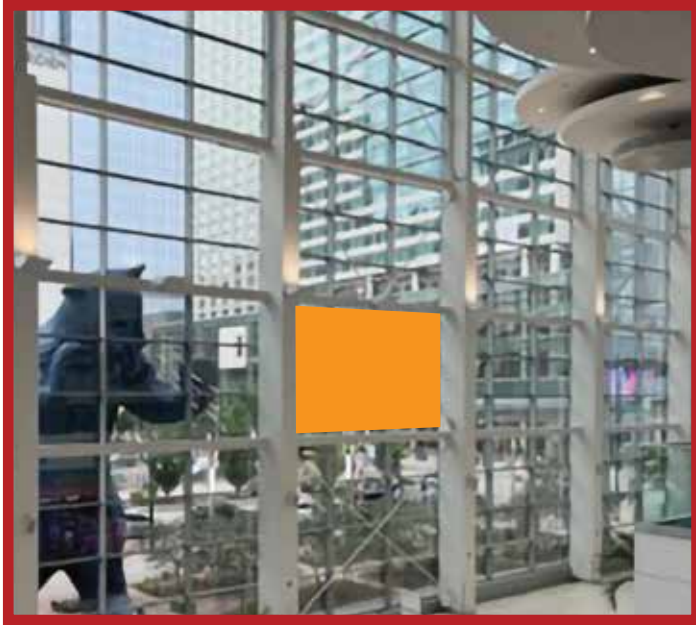

### Printing & Installation Fee

\$7,500

### Cling

27'10" W x 13'11" H

### Additional Info

Cling installed on windows near the iconic Blue Bear statue. Banner faces in towards Atrium Lobby A/F. Great view of your Cling from the entire atrium lobby.





# SIOP ANNUAL CONFERENCE

DENVER, COLORADO • April 2-5, 2025

## Lobby F Atrium Window Cling

Single Sided Facing Atrium

OPPORTUNITY #3

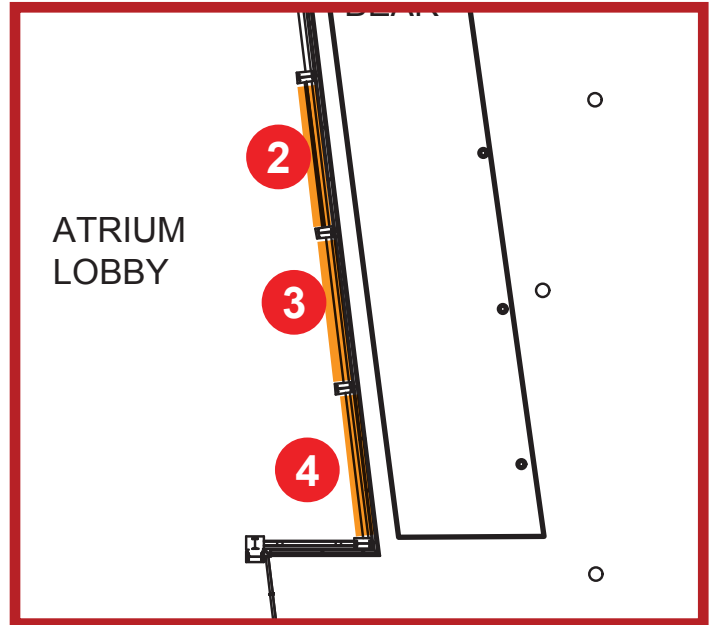

### Printing & Installation Fee

\$7,500

### Cling

27'10" W x 13'11" H

### Additional Info

Cling installed on windows near the iconic Blue Bear statue. Banner faces in towards Atrium Lobby A/F. Great view of your Cling from the entire atrium lobby.



# SIOP ANNUAL CONFERENCE

DENVER, COLORADO • April 2-5, 2025

## Lobby F Atrium Window Cling

Single Sided Facing Atrium

OPPORTUNITY #4

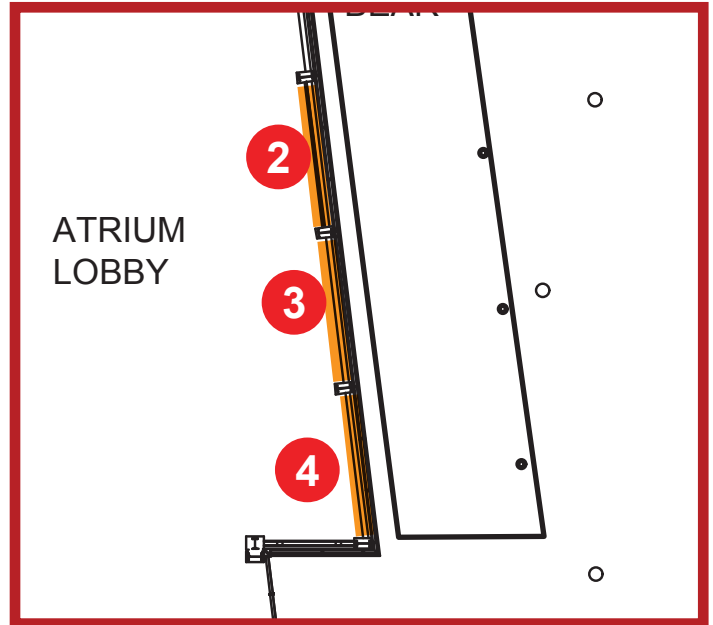

### Printing & Installation Fee

\$7,500

### Cling

---

27'10" W x 13'11" H

### Additional Info

---

Cling installed on windows near the iconic Blue Bear statue. Banner faces in towards Atrium Lobby A/F. Great view of your Cling from the entire atrium lobby.



# SIOP ANNUAL CONFERENCE

DENVER, COLORADO • April 2-5, 2025

## Atrium Lobby A Railing Banner

Single Sided Facing Atrium

OPPORTUNITY #5

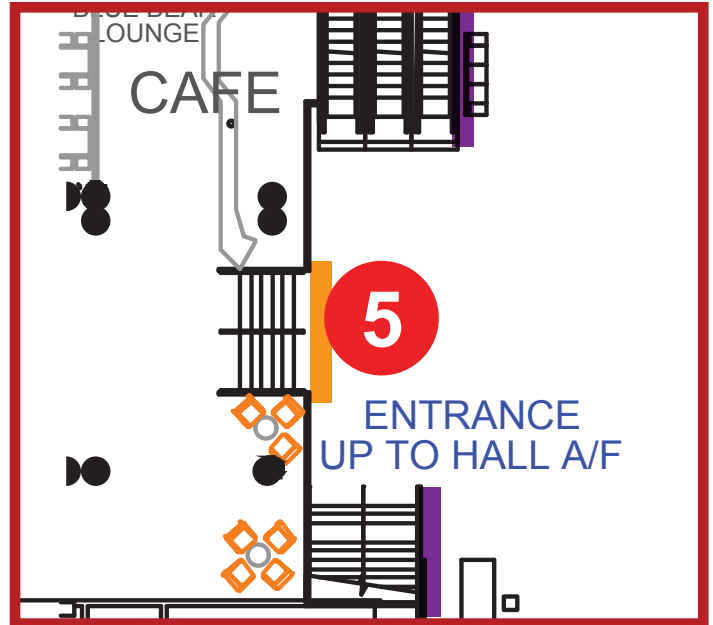

### Printing & Installation Fee

\$3,000

### Banner

30' W x 3' H

### Additional Info

Banner hangs from a railing above Atrium Lobby A. Beneath it is a path towards meeting rooms and the rest of the building. Banner is single sided facing the Atrium.

# SOLD

Thank You... PDRI by Pearson



# SIOP ANNUAL CONFERENCE

DENVER, COLORADO • April 2-5, 2025

## Atrium Lobby F Railing Banner

Single Sided Facing Atrium

OPPORTUNITY #6

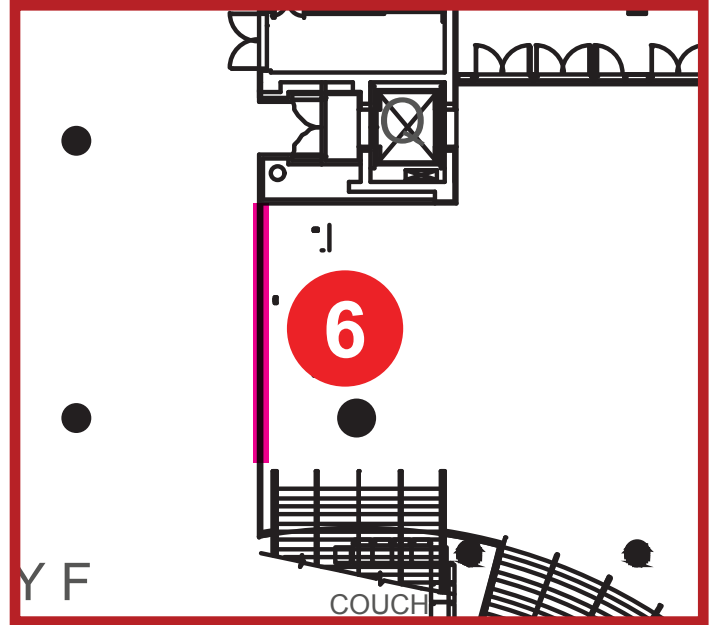

### Printing & Installation Fee

\$3,000

### Banner

30' W x 3' H

### Additional Info

Banner hangs from a railing above Atrium Lobby F. Beneath it is a path towards meeting rooms and the rest of the building. Very visible when entering the building through the Atrium Lobby F doors. Banner is single sided facing the Atrium.

# SOLD

Thank You... PDRI by Pearson



# SIOP ANNUAL CONFERENCE

DENVER, COLORADO • April 2-5, 2025

## Lobby F Wall Banner

Single Sided Facing Lobby F Across from Dazbog Café

OPPORTUNITY

#7

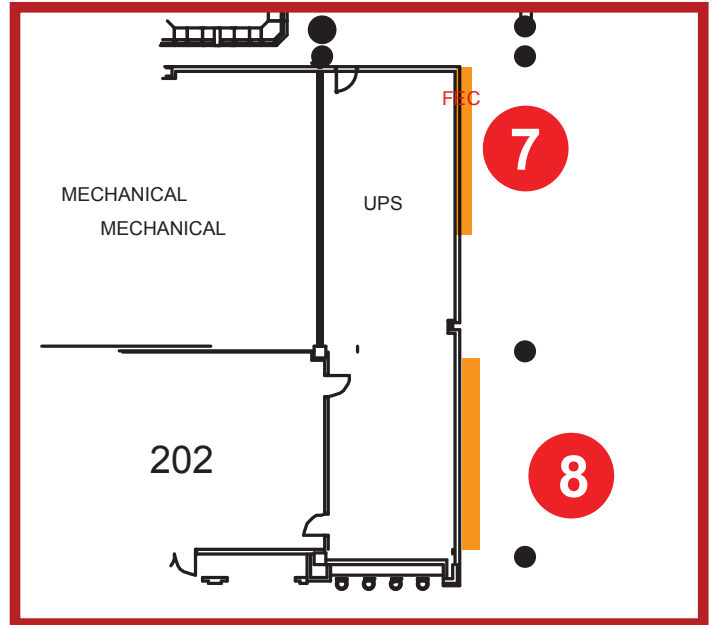

## Printing & Installation Fee

\$6,000 Price Reduced!

## Banner

20' W x 14' H

## Additional Info

This single sided banner is in a prominent location in Lobby F at the start of the Grand Concourse. You'll see it as you head down the building's central corridor to reach education, meals, general session, welcome reception, closing reception, and more.



# SIOP ANNUAL CONFERENCE

DENVER, COLORADO • April 2-5, 2025

## Lobby F Wall Banner

Single Sided Facing Lobby F Near 200 Rooms

OPPORTUNITY

#8

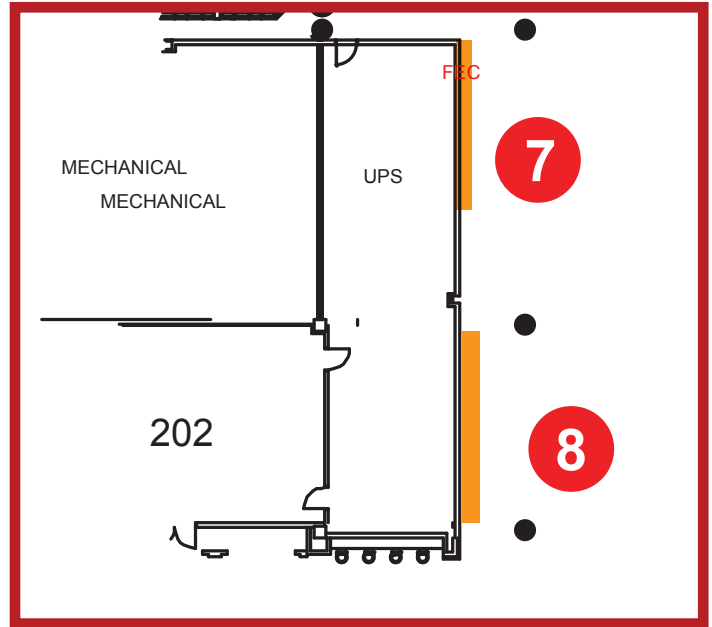

### Printing & Installation Fee

**\$6,000 Price Reduced!**

### Banner

20' W x 14' H

### Additional Info

This single sided banner is in a prominent location in Lobby F at the start of the Grand Concourse. You'll see it as you head down the building's central corridor to reach education, meals, general session, welcome reception, closing reception, and more.





# SIOP ANNUAL CONFERENCE

DENVER, COLORADO • April 2-5, 2025

## Lobby F Wall Banner

Single Sided Near CCC Offices

OPPORTUNITY

#9

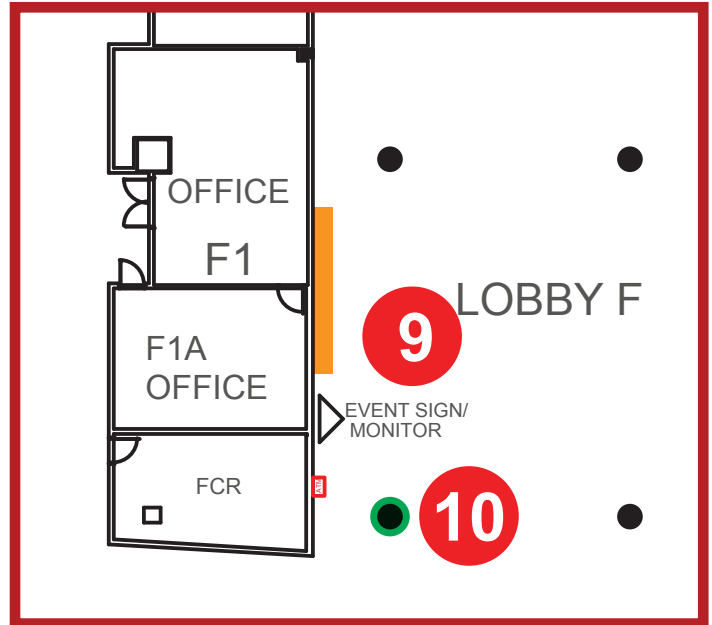

## Printing & Installation Fee

\$6,000 Price Reduced!

### Banner

20' W x 14' H

### Additional Info

This single sided banner is in a prominent location in Lobby F at the start of the Grand Concourse. You'll see it as you head down the building's central corridor to reach education, meals, general session, welcome reception, closing reception, and more. This would be a great option with opportunity 10.



# SIOP ANNUAL CONFERENCE

DENVER, COLORADO • April 2-5, 2025

## Lobby F Column Wrap

In Front of CCC Offices

OPPORTUNITY #10

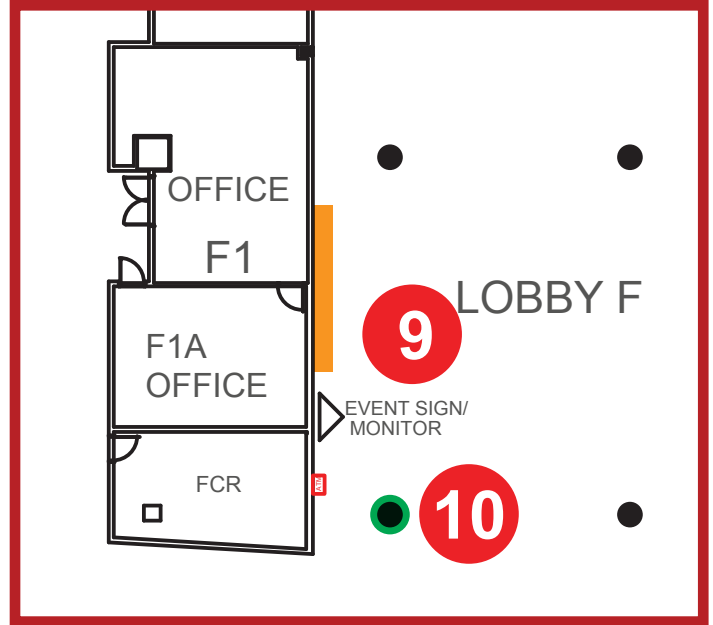

### Printing & Installation Fee

\$4,000

### Column Wrap

14' Tall

Top (x4)  
29.75" W x 70.625" H  
Bottom (x4)  
29.75" W x 92.125" H

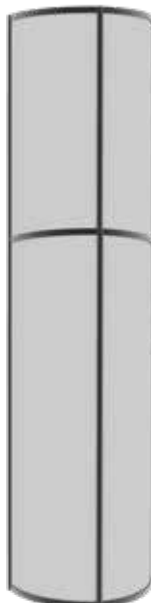

### Additional Info

This column is in a high traffic area in Lobby F on the way to Registration, Education, and the Exhibit Hall. This would be a great option with opportunity 9.





# SIOP ANNUAL CONFERENCE

DENVER, COLORADO • April 2-5, 2025

## Lobby F Column Wrap

One Column In Front of Dazbog Cafe

OPPORTUNITY #11

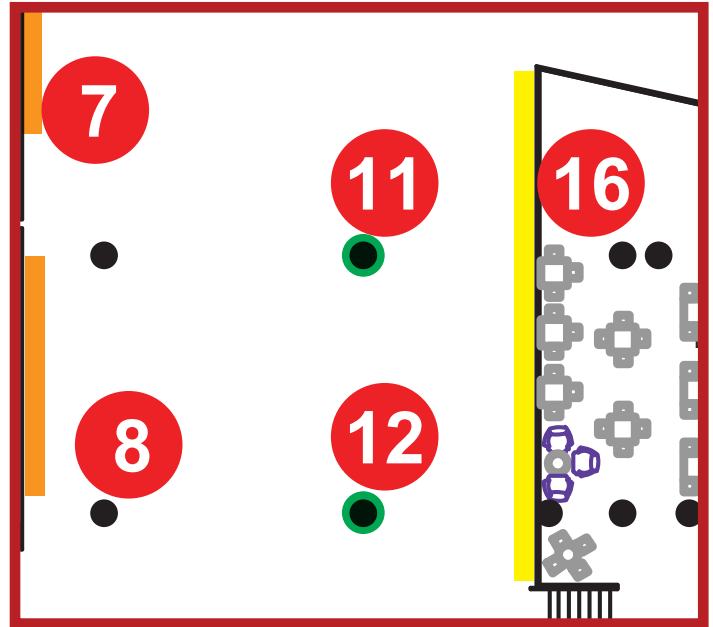

### Printing & Installation Fee

\$4,000

### Column Wrap

14' Tall

Top (x4)

29.75" W x 70.625" H

Bottom (x4)

29.75" W x 92.125" H



### Additional Info

This column is in a high traffic area in Lobby F on the way to Registration, Education, and the Exhibit Hall.



# SIOP ANNUAL CONFERENCE

DENVER, COLORADO • April 2-5, 2025

## Lobby F Column Wrap

One Column In Front of Dazbog Cafe

OPPORTUNITY #12

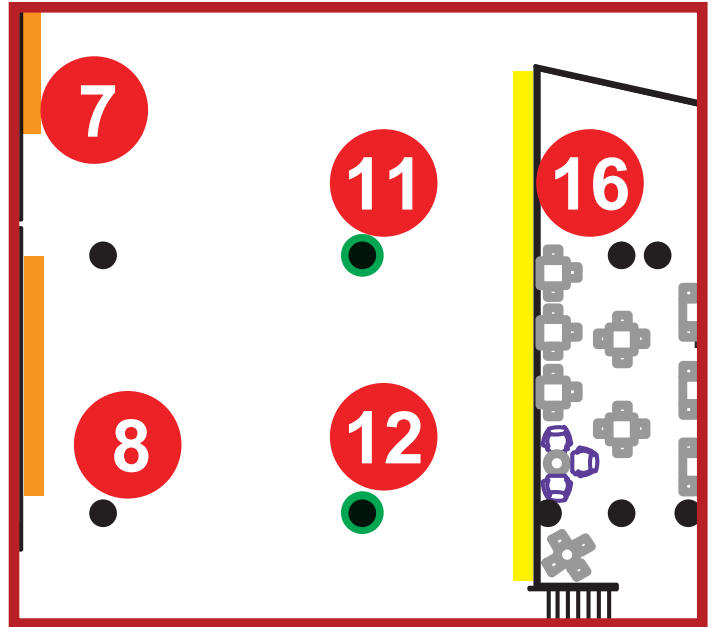

### Printing & Installation Fee

\$4,000

### Column Wrap

14' Tall

Top (x4)

29.75" W x 70.625" H

Bottom (x4)

29.75" W x 92.125" H



### Additional Info

This column is in a high traffic area in Lobby F on the way to Registration, Education, and the Exhibit Hall.



# SIOP ANNUAL CONFERENCE

DENVER, COLORADO • April 2-5, 2025

## Lobby F Column Wrap

One Column In Front of Dazbog Cafe

OPPORTUNITY #13

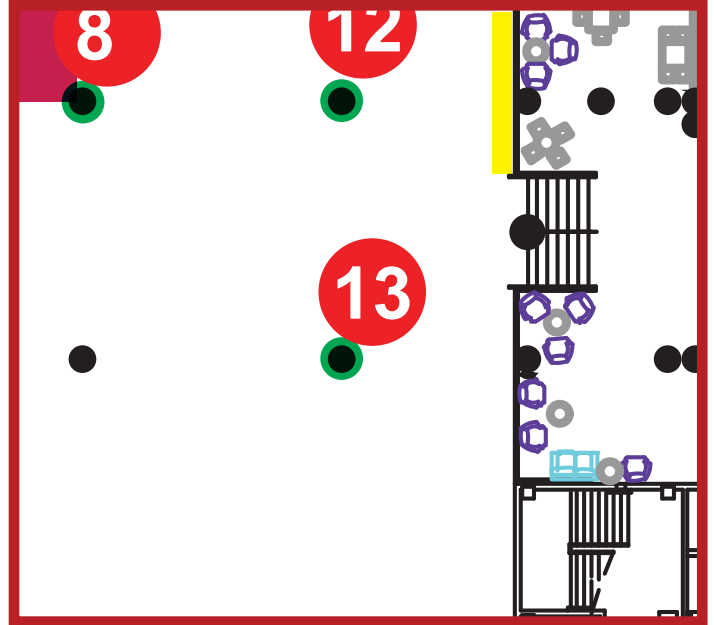

### Printing & Installation Fee

\$4,000

### Column Wrap

14' Tall

Top (x4)

29.75" W x 70.625" H

Bottom (x4)

29.75" W x 92.125" H



### Additional Info

This column is in a high traffic area in Lobby F on the way to Registration, Education, and the Exhibit Hall.



# SIOP ANNUAL CONFERENCE

DENVER, COLORADO • April 2-5, 2025

## Lobby A Column Wrap

One Column In Front of Restrooms

OPPORTUNITY #14

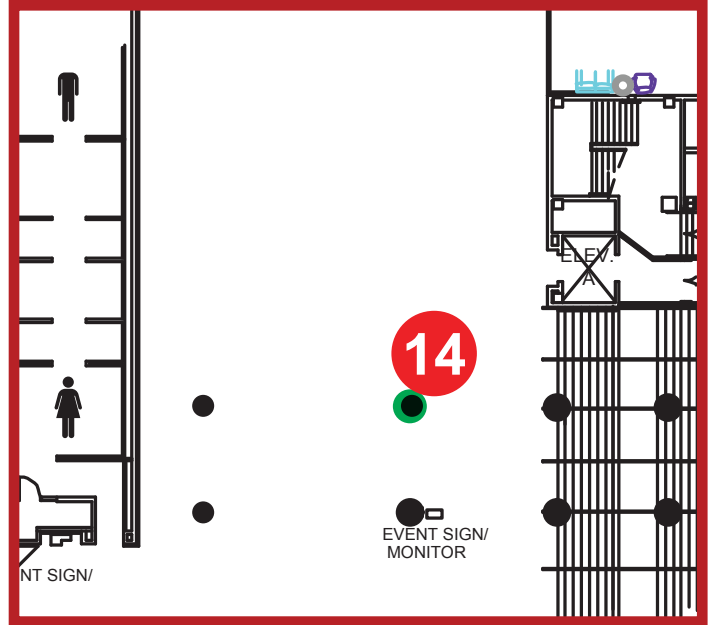

### Printing & Installation Fee

\$4,000

### Column Wrap

14' Tall

- Top (x4)  
29.75" W x 70.625" H
- Bottom (x4)  
29.75" W x 92.125" H



### Additional Info

This column is in a high traffic area in Lobby A on the way to Registration, Education, and the Exhibit Hall.

# SOLD

Thank You... SHL US LLC



# SIOP ANNUAL CONFERENCE

DENVER, COLORADO • April 2-5, 2025

## Lobby A Café Glass Clings

Dazbog Café Glass Cling Facing Grand Concourse

OPPORTUNITY #15

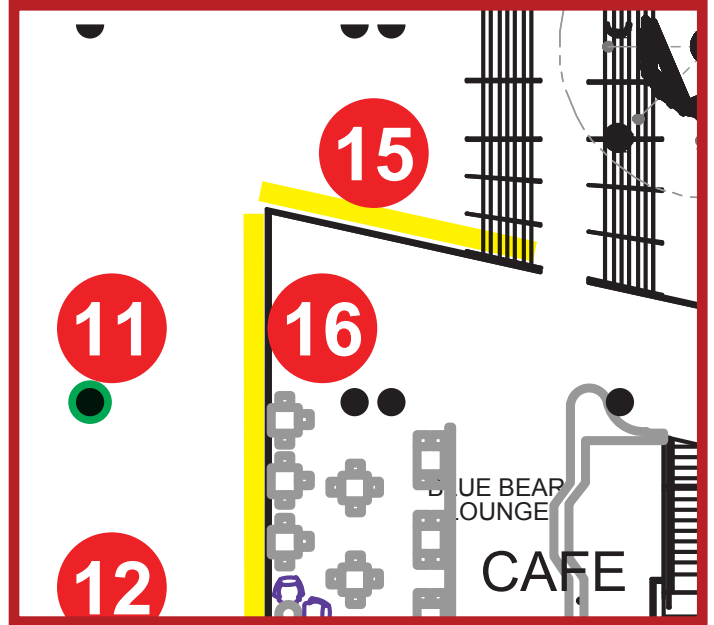

### Printing & Installation Fee

\$3,500

### Glass Panels

7 Panels (left to right)

### Additional Info

Clings face walking ramp from Lobby F to the Grand Concourse.

# SOLD

Thank You... Hogan Assessments



# SIOP ANNUAL CONFERENCE

DENVER, COLORADO • April 2-5, 2025

## Lobby A Café Glass Clings

Dazbog Café Facing Lobby A

OPPORTUNITY #16

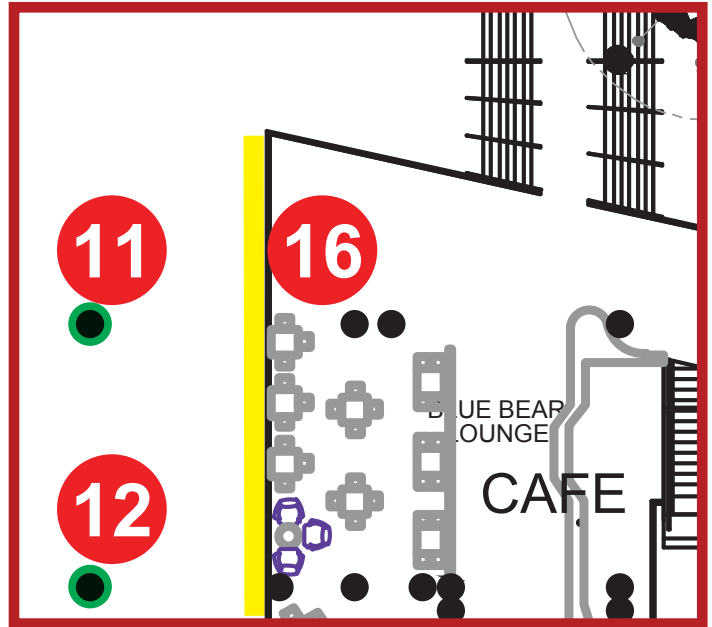

### Printing & Installation Fee

\$5,500

### Glass Panels

- 13 Panels (left to right)
- Panels 1-10 55" W x 40.5" H
- Panels 11 61.25" W x 40.5" H
- Panels 12-13 43" W x 40.5" H

### Additional Info

Clings face Wall Banners (#7 & #8) and Column Wraps (#11 & #12).

# SOLD

Thank You... Hogan Assessments





# SIOP ANNUAL CONFERENCE

DENVER, COLORADO • April 2-5, 2025

## Grand Concourse Banner

Double Sided Banner

OPPORTUNITY #17

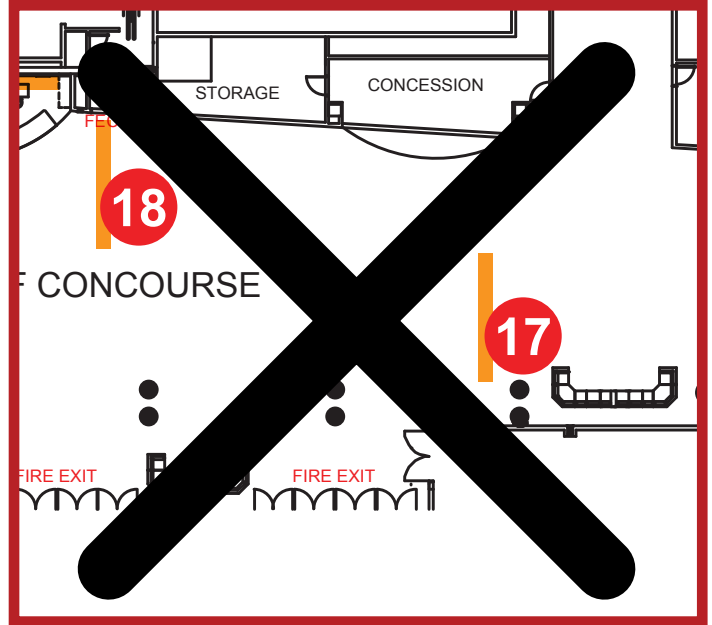

### Printing & Installation Fee

\$7,500

### Banner

15' W x 8' H

### Additional Info

Banner is double-sided. The Grand Concourse is the convention center's central corridor. It is the main path from Lobby A/F to registration, the Exhibit Hall in Mile High Ballroom and events in the Bluebird Ballroom.

# SOLD

Thank You... SHL US LLC



# SIOP ANNUAL CONFERENCE

DENVER, COLORADO • April 2-5, 2025

## Grand Concourse Banner

Double Sided Banner

OPPORTUNITY #18

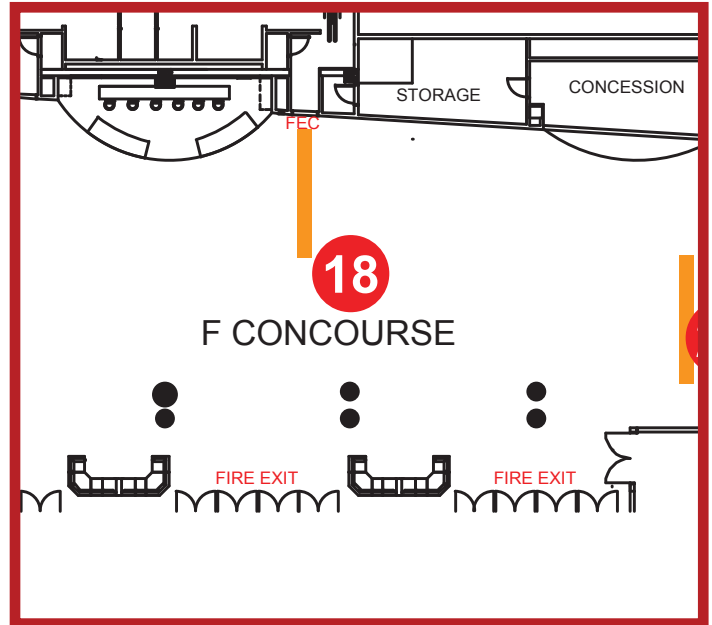

### Printing & Installation Fee

\$7,500

### Banner

15' W x 8' H

### Additional Info

Banner is double-sided. The Grand Concourse is the convention center's central corridor. It is the main path from Lobby A/F to registration, the Exhibit Hall in Mile High Ballroom and events in the Bluebird Ballroom.





# SIOP ANNUAL CONFERENCE

DENVER, COLORADO • April 2-5, 2025

## Grand Concourse Banner

Double Sided Banner

OPPORTUNITY #19

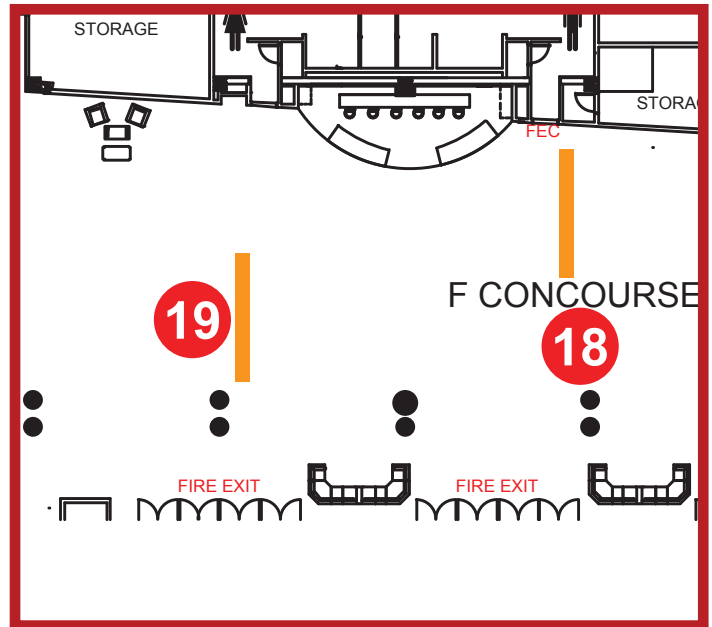

### Printing & Installation Fee

\$7,500

### Banner

15' W x 8' H

### Additional Info

Banner is double-sided. The Grand Concourse is the convention center's central corridor. It is the main path from Lobby A/F to registration, the Exhibit Hall in Mile High Ballroom and events in the Bluebird Ballroom.



# SIOP ANNUAL CONFERENCE

DENVER, COLORADO • April 2-5, 2025

## Device Charging Seating Area - Grand Concourse by 400 Rooms **OPPORTUNITY #20**

Graphics on Backwalls and Clings on Curved Seating

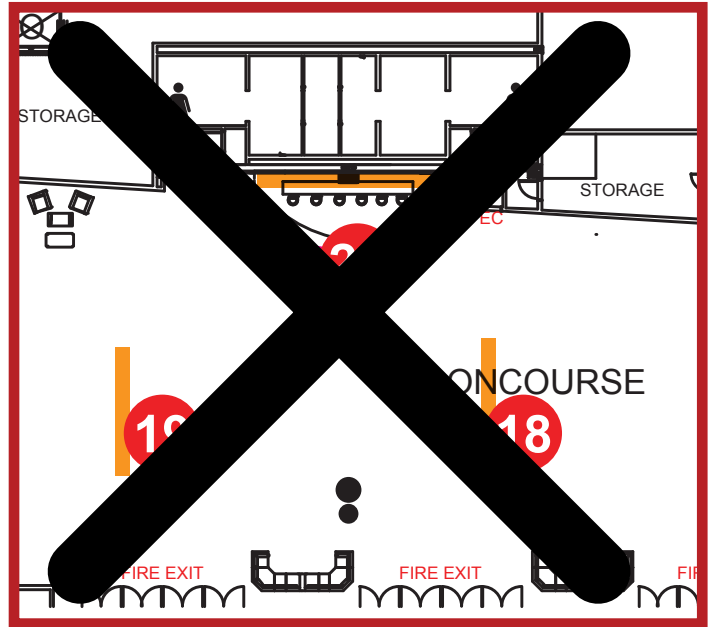

### Printing & Installation Fee

\$10,000

### Backwall

Left Piece: 106.5" Wide x 87.75" High  
Center Piece: 59.75" Wide x 87.75" High  
Right Piece: 106.5" Wide x 87.75" High

### Curved Seating

Fronts (x2) 9'6" W x 13.5" H  
Ends (x4) 28" W x 13.5" H

### Table Top

21' Long x 24" Wide

### Additional Info

This area has built-in counters, stools, and benches with power outlets to charge your devices. It is located in the Grand Concourse, which is the convention center's central corridor. It is situated close to one of the escalators that go down to the Mile High Ballroom. You may brand the sides of the curved benches and the panels on the backwalls.

# SOLD

**Thank You... Valence**



# SIOP ANNUAL CONFERENCE

DENVER, COLORADO • April 2-5, 2025

## Grand Concourse Panels

SEG Wall

OPPORTUNITY #21

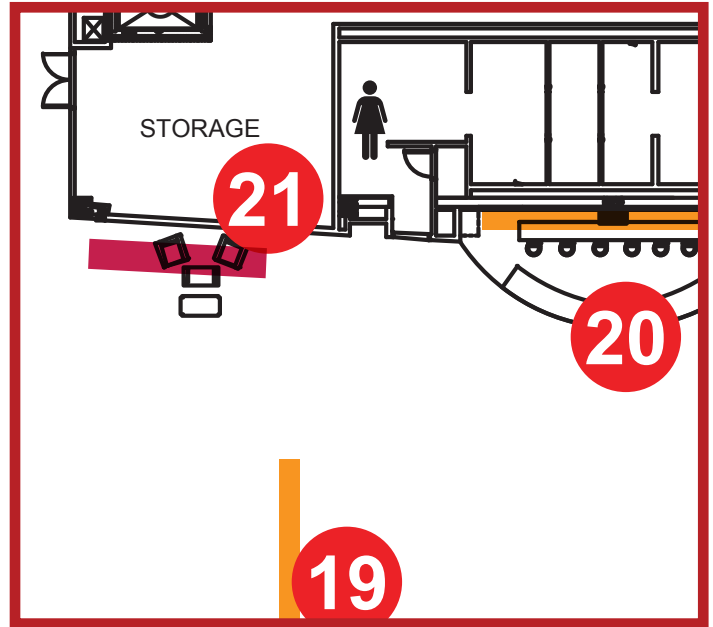

## Printing & Installation Fee

\$5,000

## SEG Wall

1 panels wide, 1116.625" Wide x 94.9375" High

## Additional Info

This sign will be in a high traffic area in the Grand Concourse on the way to the Exhibit Hall and Registration.

# SOLD

Thank You... Deloitte Consulting



# SIOP ANNUAL CONFERENCE

DENVER, COLORADO • April 2-5, 2025

## Grand Concourse Panels

SEG Wall

OPPORTUNITY #22

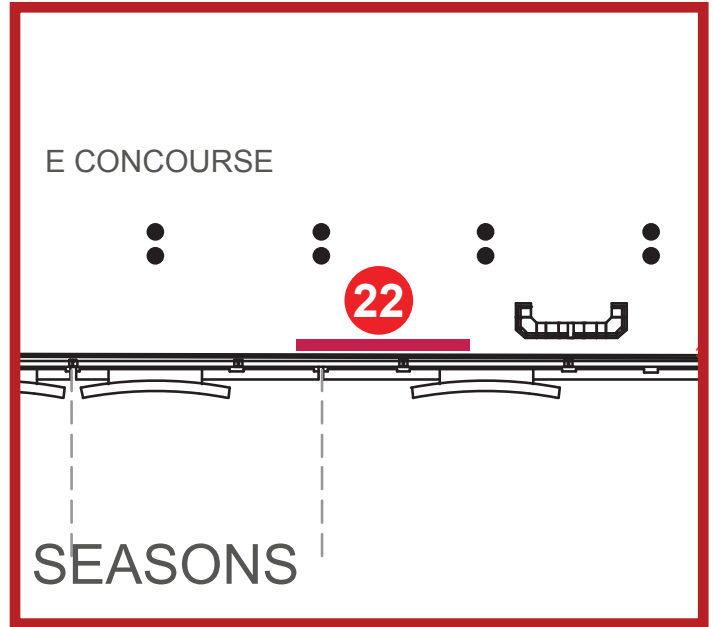

## Printing & Installation Fee

\$5,000

### SEG Wall

3 panels wide, each 38.875" Wide x 94.9375" High

### Additional Info

This sign will be near registration and nearly all the traffic will pass by this sign when arriving.

# SOLD

Thank You... HackerRank



# SIOP ANNUAL CONFERENCE

DENVER, COLORADO • April 2-5, 2025

## Wall Cling

Hallway to the 200 Rooms

OPPORTUNITY #23

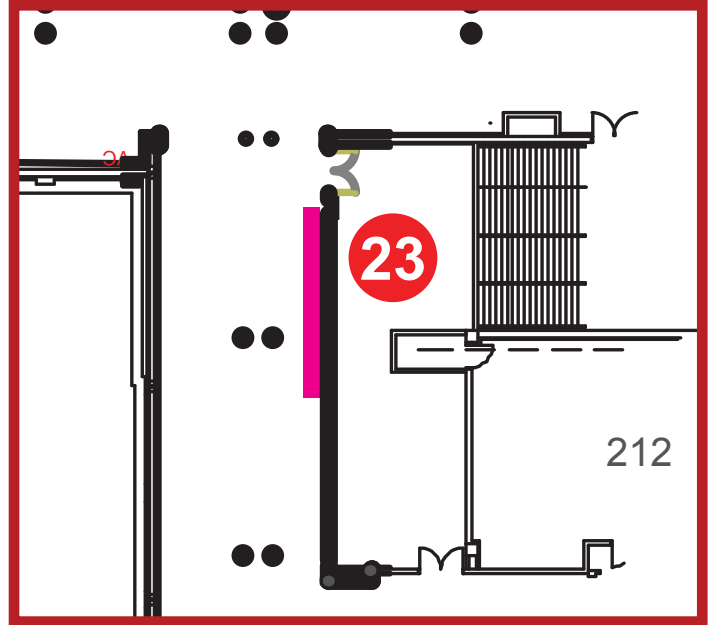

## Printing & Installation Fee

\$2,500

## Wall Cling

96" Wide x 47" High

## Additional Info

High visibility graphic in the hallway on the way to educational sessions.

# SOLD

Thank You... Neimenick Consulting



# SIOP ANNUAL CONFERENCE

DENVER, COLORADO • April 2-5, 2025

## Grand Concourse Glass Cling

Overlooking Mile High Ballroom Prefunction Near the 400 Rms

OPPORTUNITY **#24**

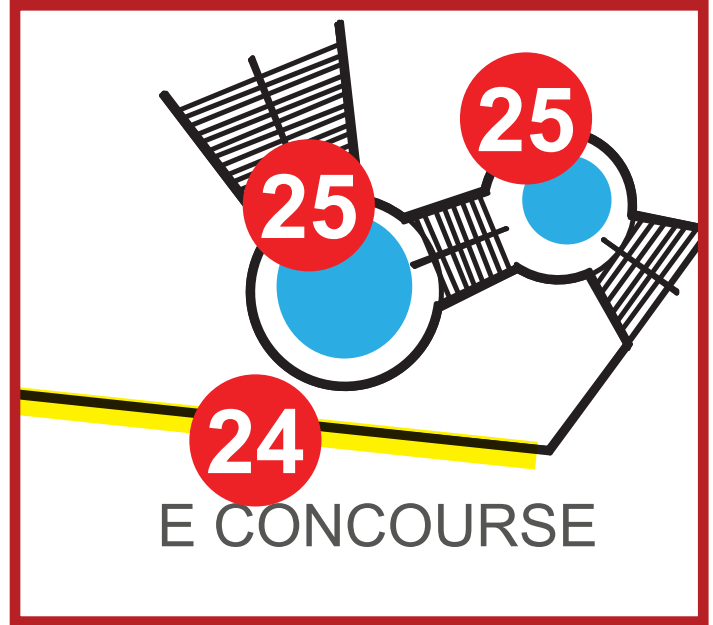

### Printing & Installation Fee

\$7,500

### Glass Cling

339" Wide x 40.25" High

### Additional Info

High traffic area outside of registration and above the exhibit hall.



# SIOP ANNUAL CONFERENCE

DENVER, COLORADO • April 2-5, 2025

## Stair Landing Clings from Grand Concourse to Mile High Ballroom Round Floor Clings on Both Landings of the Stairs

OPPORTUNITY #25

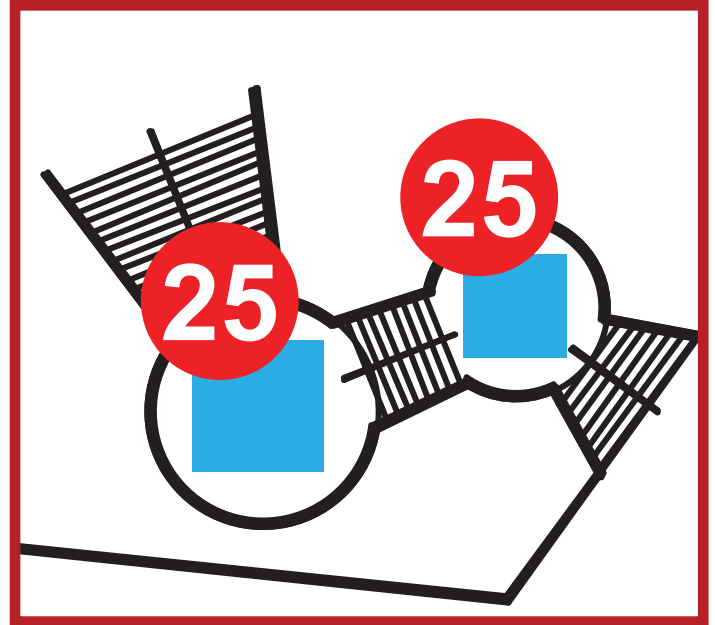

### Printing & Installation Fee

\$2,750 each

### Floor Cling

---

Upper Landing 9' Diameter  
Lower Landing 12' Diameter

### Additional Info

---

These stairs go from the Grand Concourse to the Mile High Ballroom. Very visible from Grand Concourse even if you are not headed down the stairs.





# SIOP ANNUAL CONFERENCE

DENVER, COLORADO • April 2-5, 2025

## Grand Concourse Railing Glass Clings

Facing Grand Concourse

OPPORTUNITY #26

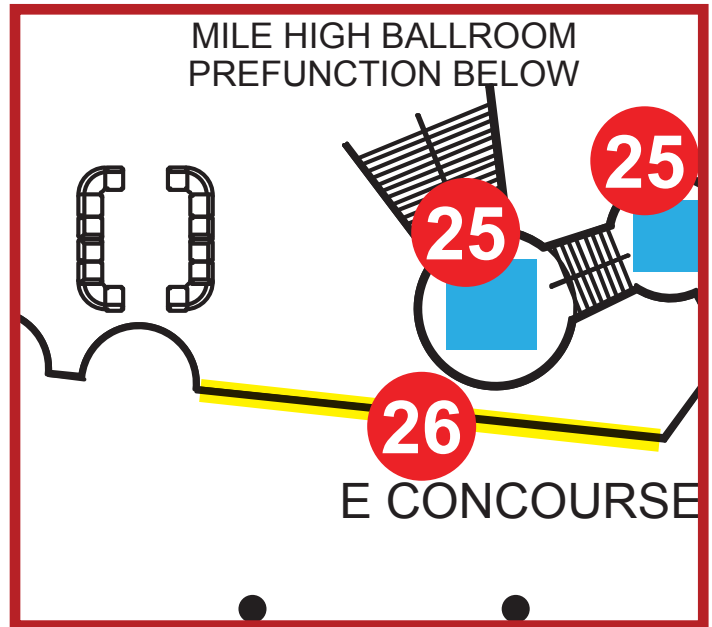

### Printing & Installation Fee

\$10,000

### Glass Clings

11 Panels (L-R)

Panel 1 63.5" W x 40.5" H

Panel 2 53.25" W x 40.5" H

Panels 3-11 58.5" W x 40.5" H

### Additional Info

Visible from the Grand Concourse, your graphics on this railing will be seen by guests as they travel through the Grand Concourse to the general session, trade show entrances, meals, and receptions. Because the glass railing is located directly above the Mile High Ballroom foyer, it will also be seen as guests approach the escalator or stairs to head down to that ballroom for exhibits.





# SIOP ANNUAL CONFERENCE

DENVER, COLORADO • April 2-5, 2025

## Grand Concourse Railing Glass Clings

Facing Grand Concourse

OPPORTUNITY #27

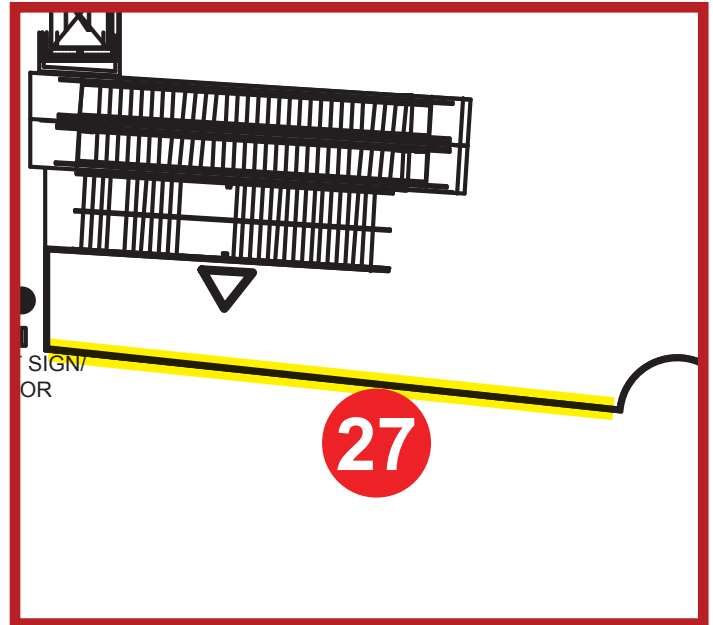
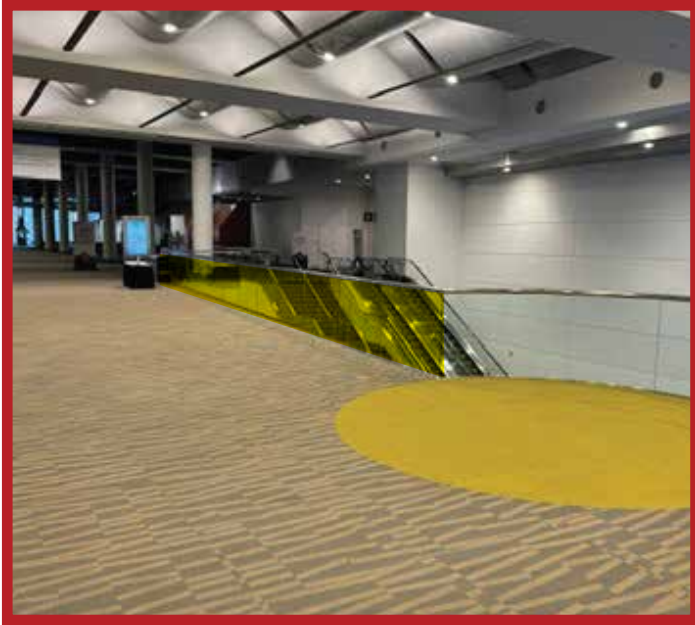

### Printing & Installation Fee

\$10,000

### Glass Clings

- 13 Panels (L-R)
- Panels 1-11 60.75" W x 40.5" H
- Panel 12 57.25" W x 40.5" H
- Panel 13 63.5" W x 40.5" H

### Additional Info

Visible from the Grand Concourse, your graphics on this railing will be seen by guests as they travel through the Grand Concourse to the general session, trade show entrances, meals, and receptions. Because the glass railing is located directly above the Mile High Ballroom foyer, it will also be seen as guests approach the escalator or stairs to head down to that ballroom for exhibits.



# SIOP ANNUAL CONFERENCE

DENVER, COLORADO • April 2-5, 2025

## Bematrix Box

Near the top of escalators to Mile High Ballroom Prefunction

OPPORTUNITY #28

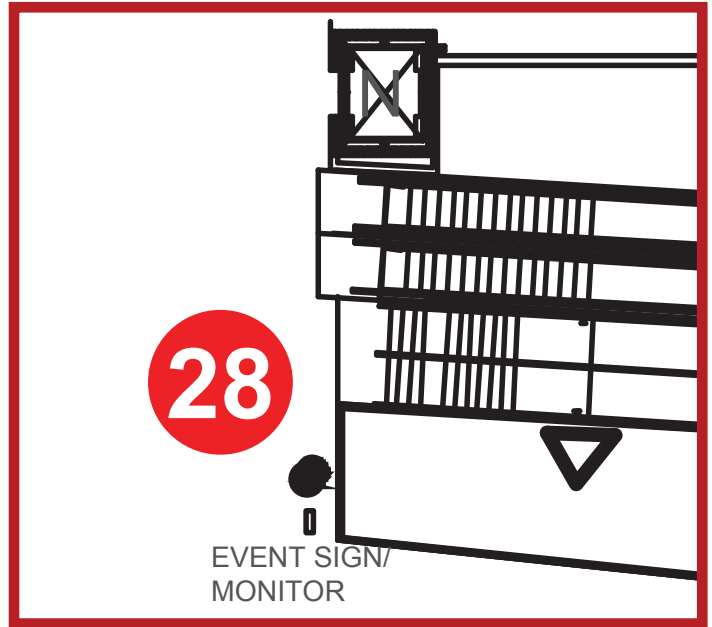

### Printing & Installation Fee

**\$5,000 Price Reduced!**

### Bematrix Box

4 panels, each 38.875" Wide x 94.9375" High

### Additional Info

4 sided box in a high traffic area at the top of the escalator from the Exhibit Hall to educational rooms and Bluebird events.

# SOLD

**Thank You... Deloitte Consulting**



# SIOP ANNUAL CONFERENCE

DENVER, COLORADO • April 2-5, 2025

## Mini Lounge

Two chairs & charging table

OPPORTUNITY **#29**

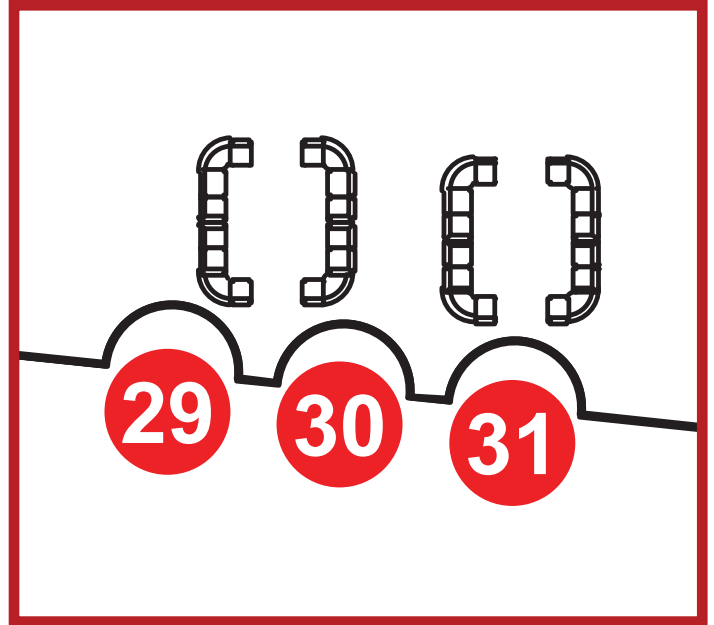

## Printing & Installation Fee

\$5,000

### Additional Info

Lounge across from Registration and overlooking Mile High Prefunction Space. Area will have two comfortable chairs with a charging table.

# SOLD

**Thank You... Valence**



# SIOP ANNUAL CONFERENCE

DENVER, COLORADO • April 2-5, 2025

## Mini Lounge

Two chairs & charging table

OPPORTUNITY **#30**

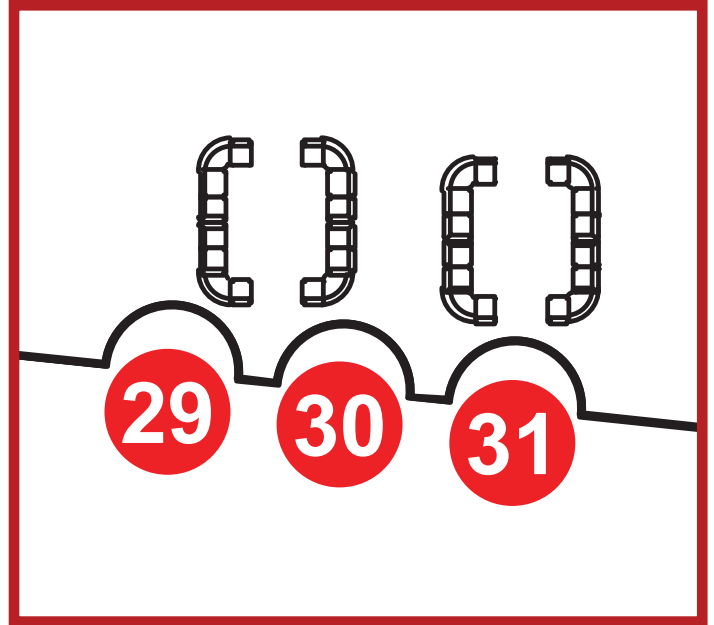

## Printing & Installation Fee

\$5,000

### Additional Info

Lounge across from Registration and overlooking Mile High Prefunction Space. Area will have two comfortable chairs with a charging table.

# SOLD

**Thank You... Valence**



# SIOP ANNUAL CONFERENCE

DENVER, COLORADO • April 2-5, 2025

## Mini Lounge

Two chairs & charging table

OPPORTUNITY **#31**

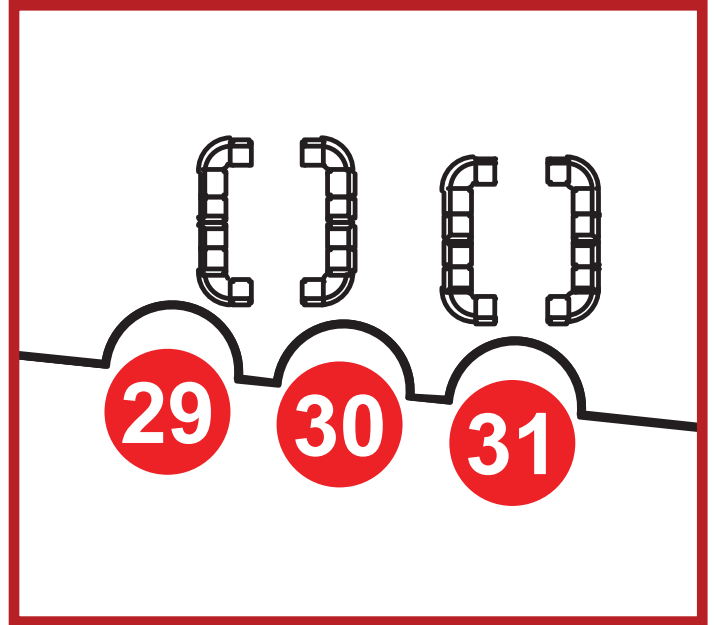

## Printing & Installation Fee

\$5,000

### Additional Info

Lounge across from Registration and overlooking Mile High Prefunction Space. Area will have two comfortable chairs with a charging table.

# SOLD

**Thank You... Valence**



# SIOP ANNUAL CONFERENCE

DENVER, COLORADO • April 2-5, 2025

## Grand Concourse Banner

Double Sided Banner

OPPORTUNITY **#32**

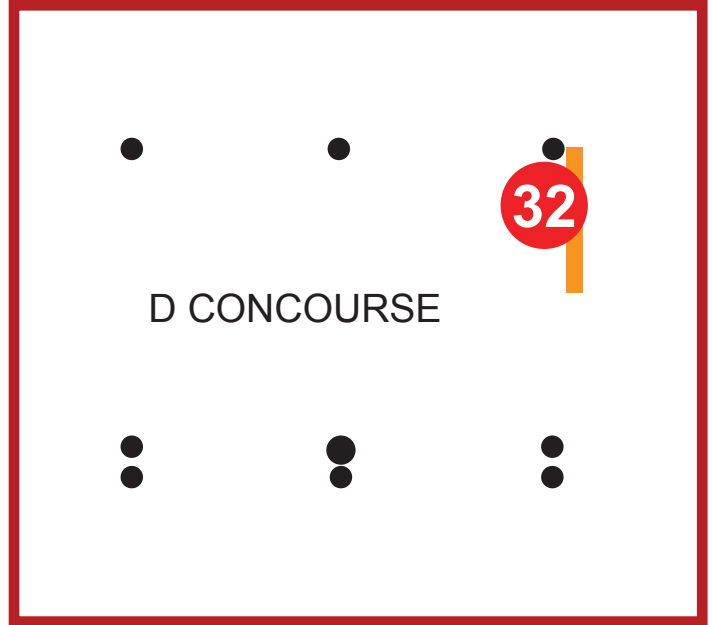

### Printing & Installation Fee

\$7,500

### Banner

15' W x 8' H

### Additional Info

Banner is double-sided. The Grand Concourse is the convention center's central corridor. It is the main path from Lobby A/F to the exhibits in Mile High Ballroom, and events held in the Bluebird Ballroom.



# SIOP ANNUAL CONFERENCE

DENVER, COLORADO • April 2-5, 2025

## Mile High Ballroom Prefunction Wall Banner

SEG frame panels

OPPORTUNITY #33

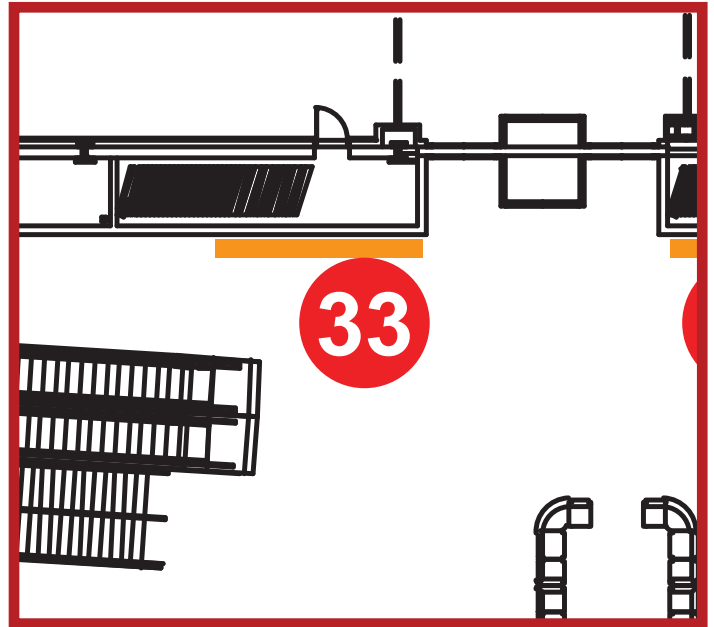

### Printing & Installation Fee

\$5,000

### SEG Wall

3 panels wide, each 38.875" Wide x 94.9375" High

### Additional Info

3 panel wall at the bottom of the escalator going to the Exhibit Hall

# SOLD

Thank You... SHL US LLC





# SIOP ANNUAL CONFERENCE

DENVER, COLORADO • April 2-5, 2025

## Mile High Ballroom Prefunction Wall Banner

SEG frame panels

OPPORTUNITY **#34**

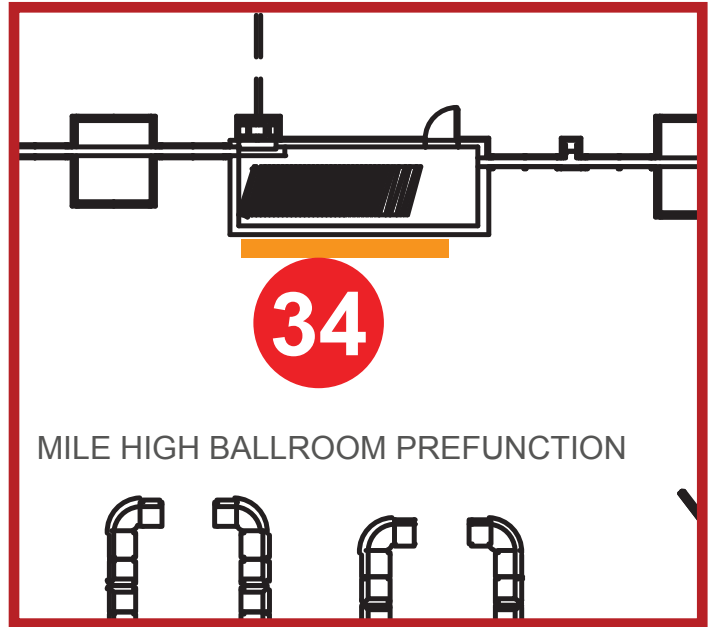

### Printing & Installation Fee

\$5,000

### SEG Wall

3 panels wide, each 38.875" Wide x 94.9375" High

### Additional Info

3 panel wall next to the entrance to the Exhibit Hall

# SOLD

Thank You... SHL US LLC





# SIOP ANNUAL CONFERENCE

DENVER, COLORADO • April 2-5, 2025

## Mile High Ballroom Prefunction Wall Banner

SEG frame panels

OPPORTUNITY **#35**

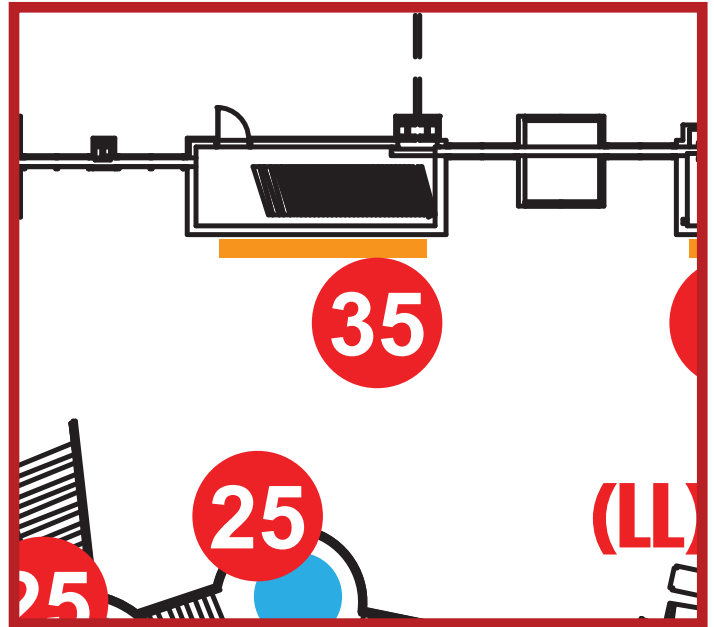

### Printing & Installation Fee

\$5,000

### SEG Wall

3 panels wide, each 38.875" Wide x 94.9375" High

### Additional Info

3 panel wall next to the entrance to the Exhibit Hall

# SOLD

Thank You... APTMetrics



# SIOP ANNUAL CONFERENCE

DENVER, COLORADO • April 2-5, 2025

## Mile High Ballroom Prefunction Wall Banner

SEG frame panels

OPPORTUNITY **#36**

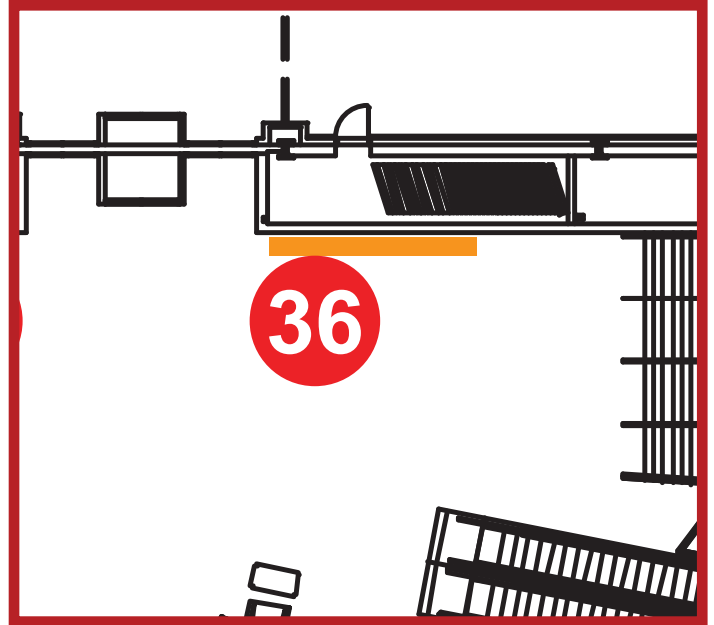

### Printing & Installation Fee

\$5,000

### SEG Wall

3 panels wide, each 38.875" Wide x 94.9375" High

### Additional Info

3 panel wall at the bottom of the stairs going to the Exhibit Hall

# SOLD

Thank You... SHL US LLC



# SIOP ANNUAL CONFERENCE

DENVER, COLORADO • April 2-5, 2025

## Wall Cling

Hallway to the 600 Rooms

OPPORTUNITY **#37**

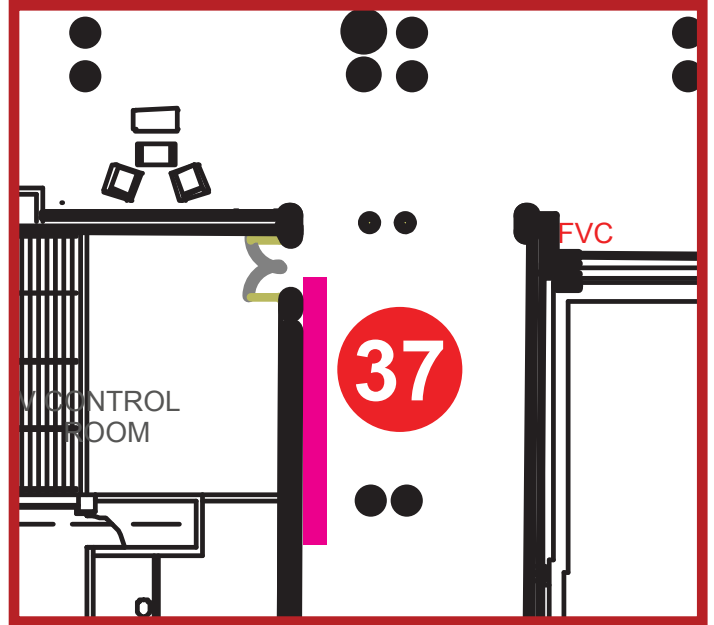

## Printing & Installation Fee

\$2,500

## Wall Cling

96" Wide x 47" High

## Additional Info

High visibility graphic in the hallway on the way to educational sessions.

# SOLD

Thank You... Pinsight



# SIOP ANNUAL CONFERENCE

DENVER, COLORADO • April 2-5, 2025

## Lobby C/D Box Column Wrap

Double column

OPPORTUNITY #38

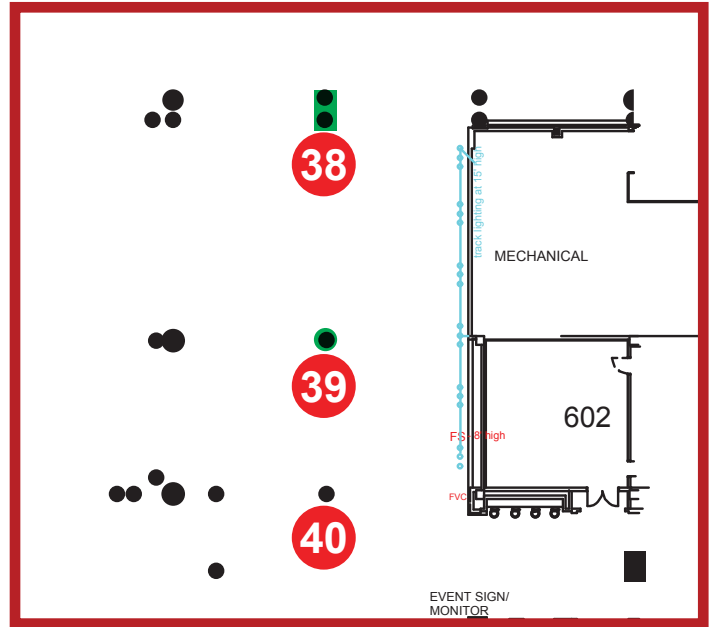

## Printing & Installation Fee

\$12,500

## Column Wrap

Rectangle around both columns  
Side (4 panels each side)  
Top Row (x4) 54.5" W x 70.625" H  
Bottom Row (x4) 54.5" W x 92.125" H

Ends (2 panels each end)  
Top Row (x2) 54.5" W x 70.625" H  
Bottom Row (x2) 54.5" W x 92.125" H

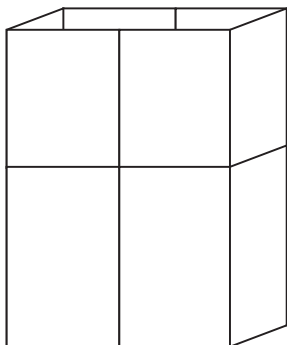

## Additional Info

This part of Lobby C/D expected to be a heavily traveled path. It is adjacent to the Bellco Theater lobby (location of General Session), and is at the base of the escalators that lead up to the Trade Show Hall D entrance and the Bluebird Ballroom (location of meals, welcome reception, closing reception, and more).



# SIOP ANNUAL CONFERENCE

DENVER, COLORADO • April 2-5, 2025

## Lobby C/D Column Wrap

OPPORTUNITY #39

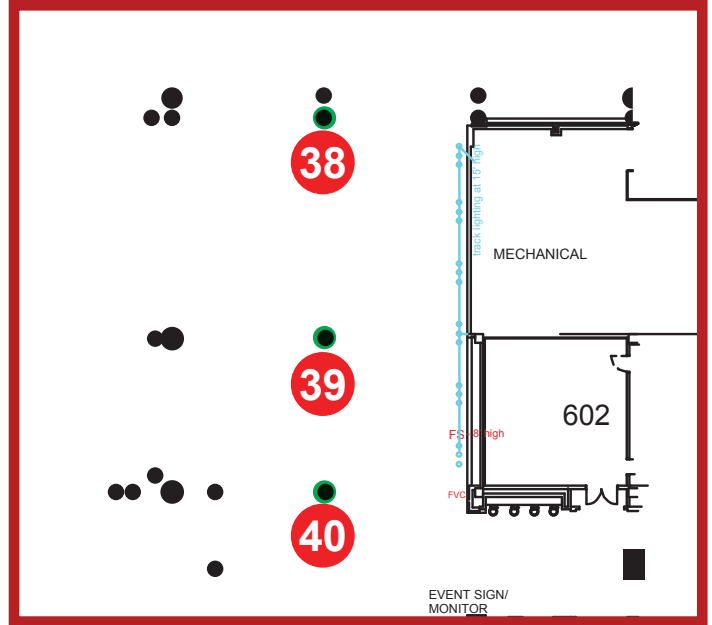

### Printing & Installation Fee

\$4,000

### Column Wrap

14' Tall

Top (x4)

42.75" W x 70.625" H

Bottom (x4)

42.75" W x 92.125" H



### Additional Info

This part of Lobby C/D expected to be a heavily traveled path. It is adjacent to the Bellco Theater lobby (location of General Session), and is at the base of the escalators that lead up to the Trade Show Hall D entrance and the Bluebird Ballroom (location of meals, welcome reception, closing reception, and more).



# SIOP ANNUAL CONFERENCE

DENVER, COLORADO • April 2-5, 2025

## Lobby C/D Column Wrap

OPPORTUNITY #40

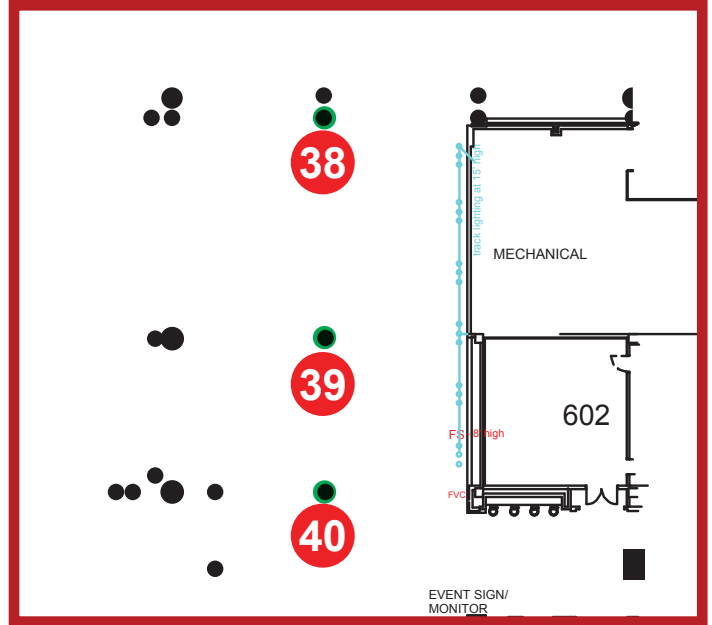

### Printing & Installation Fee

\$4,000

### Column Wrap

14' Tall

Top (x4)

29.75" W x 70.625" H

Bottom (x4)

29.75" W x 92.125" H

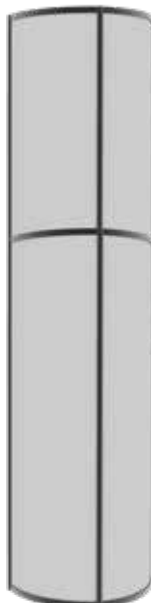

### Additional Info

This part of Lobby C/D expected to be a heavily traveled path. It is adjacent to the Bellco Theater lobby (location of General Session), and is at the base of the escalators that lead up to the Trade Show Hall D entrance and the Bluebird Ballroom (location of meals, welcome reception, closing reception, and more).



# SIOP ANNUAL CONFERENCE

DENVER, COLORADO • April 2-5, 2025

## Lobby C/D Column Wrap

OPPORTUNITY #41

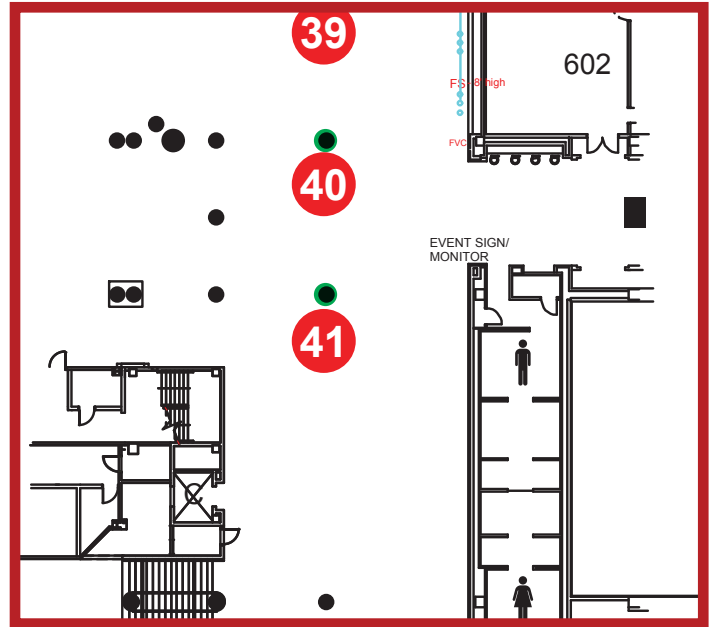

### Printing & Installation Fee

\$4,000

### Column Wrap

14' Tall

Top (x4)

29.75" W x 70.625" H

Bottom (x4)

29.75" W x 92.125" H



### Additional Info

This part of Lobby C/D expected to be a heavily traveled path. It is adjacent to the Bellco Theater lobby (location of General Session), and is at the base of the escalators that lead up to the Trade Show Hall D entrance and the Bluebird Ballroom (location of meals, welcome reception, closing reception, and more).





# SIOP ANNUAL CONFERENCE

DENVER, COLORADO • April 2-5, 2025

## Charging Station Table Top and Back Wall

Near Room 602

OPPORTUNITY #42

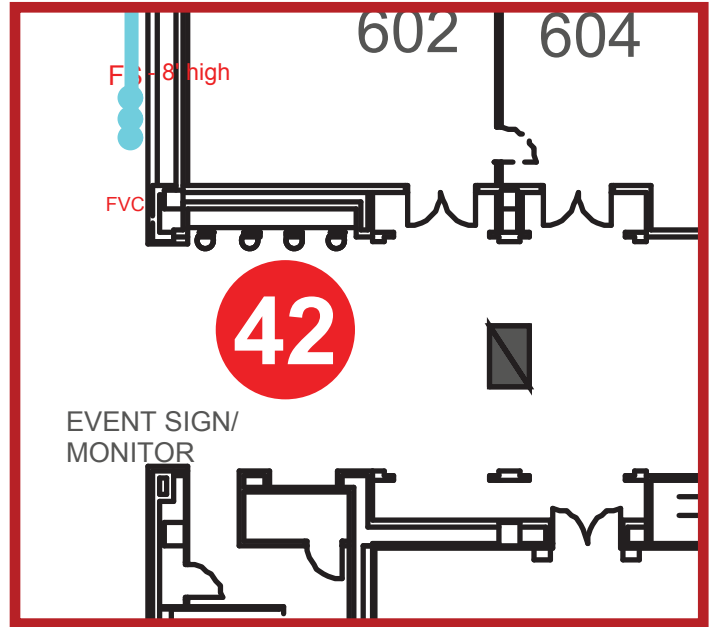

### Printing & Installation Fee

\$4,000

### Back Wall

162" Wide x 55" High

### Counter Top

161.75" Wide x 20" High

### Additional Info

This charging station will be near the education rooms. Graphics will be added to the backdrop and the table top.



# SIOP ANNUAL CONFERENCE

DENVER, COLORADO • April 2-5, 2025

## Lounge Off of Stairs Up to Birdbird

Sofa, Chairs, Charging Table

OPPORTUNITY #43

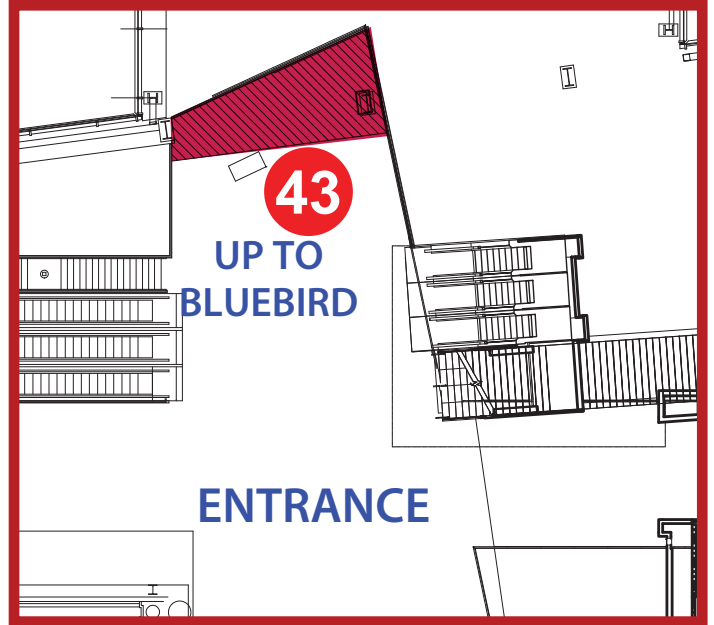

### Printing & Installation Fee

\$7,500

### Charging Table

Top: 48" Wide x 48" High  
Sides: 48" Wide x 17" High (x4)

### Hoffa

38" Wide x 96" High (x2)

### Additional Info

This lounge will get heavy traffic as everyone going to Bluebird will see it with two Meter Boards and sponsored charging cube this lounge will be a welcoming area for a break in between sessions.

# SOLD



Thank You... Hogan Assessments



# SIOP ANNUAL CONFERENCE

DENVER, COLORADO • April 2-5, 2025

## Column Wrap

Across from Blue Bird Ballroom

OPPORTUNITY #44

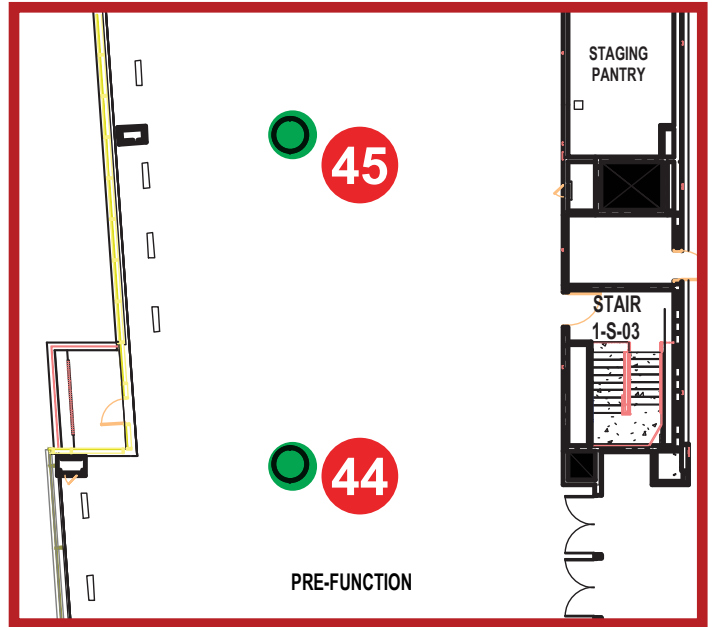

## Printing & Installation Fee

\$4,000

## Column Wrap

14' Tall

Top (x4)

29.75" W x 70.625" H

Bottom (x4)

29.75" W x 92.125" H



## Additional Info

This column is in a high traffic area in the prefunction space of the Blue Bird Ballroom near its main entrance.

The Opening Plenary and the Welcome Reception to scheduled to be held in the Blue Bird Ballroom.



# SIOP ANNUAL CONFERENCE

DENVER, COLORADO • April 2-5, 2025

## Column Wrap

Across from Blue Bird Ballroom

OPPORTUNITY #45

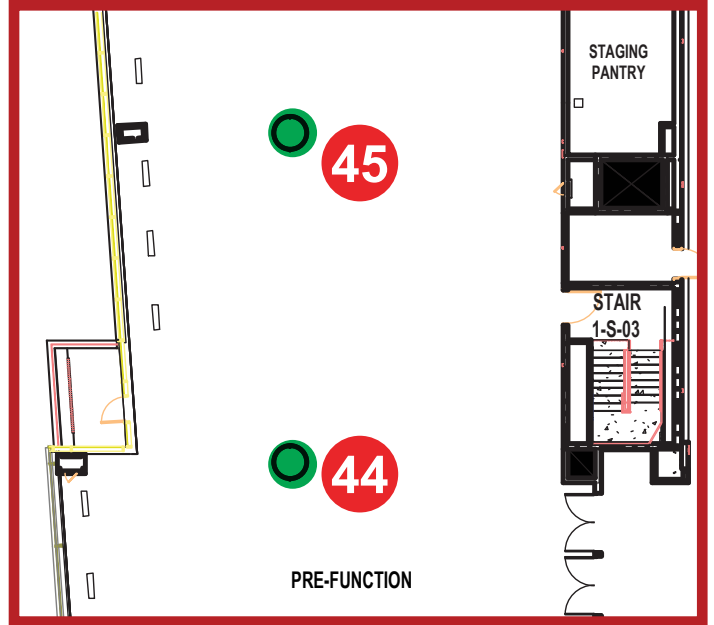

## Printing & Installation Fee

\$4,000

## Column Wrap

14' Tall

Top (x4)

29.75" W x 70.625" H

Bottom (x4)

29.75" W x 92.125" H



## Additional Info

This column is in a high traffic area in the prefunction space of the Blue Bird Ballroom near its main entrance.

The Opening Plenary and the Welcome Reception to scheduled to be held in the Blue Bird Ballroom.